

Equipped troughs

Equipped troughs

Code: 3024 800



DETAILS

Edge/Installation Type Flush-mount | Top-mount

Material AISI 304 stainless steel

Finish Foster brushed

Texture Brushed in line

Base 45 cm

External dimensions 450 x 170 mm

Internal dimensions 422 x 142 mm

Width 45 cm

Length 3 unit - Standard

Built-in hole

[View technical data sheet](#)

Standard fittings

Fixing hooks, gasket, drain, boxed packing

Waste fitting

1¼" drain

Key to understanding the accessories

The lengths of the channels and accessories are indicated in “units”; for the composition, the sum of the “units” of the accessories must be the same as the length in “units” of the channel.

FEATURES

High thickness

1mm thick steel. A significant thickness, which guarantees the maximum sturdiness and durability.

TECHNICAL DATA

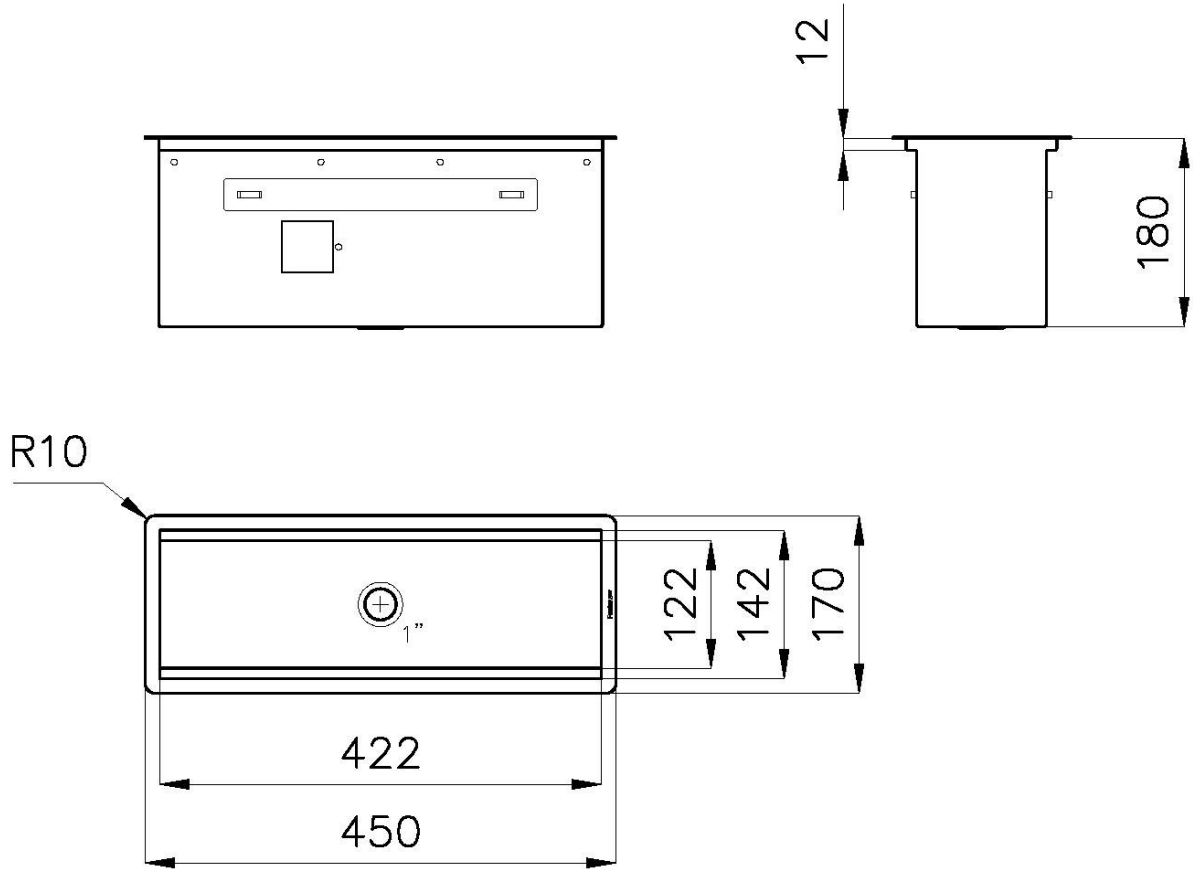

Filotop/Flush-mount

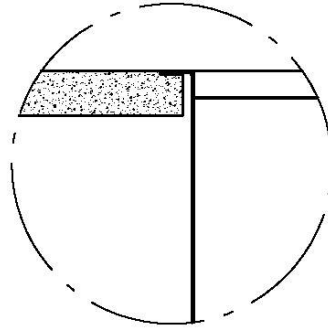

B-B:
Dettaglio installazione
Installation detail

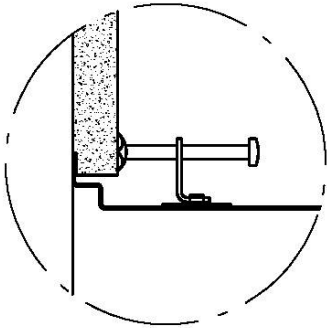

A-A:
Dettaglio installazione e sistema di fissaggio
Installation detail and fixing system

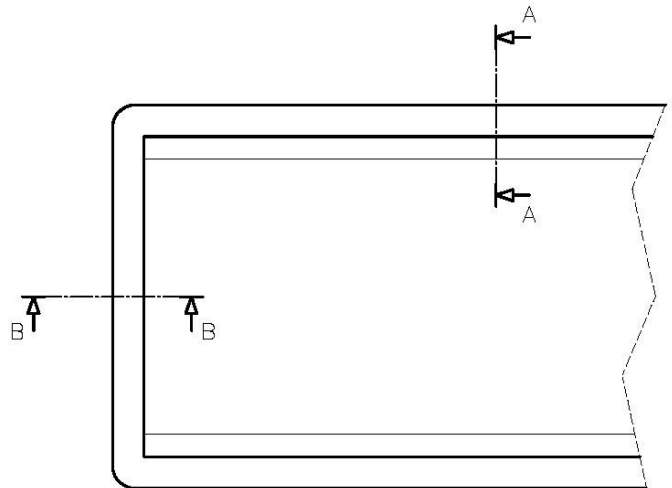

Dimensioni per foratura top
Cut out size

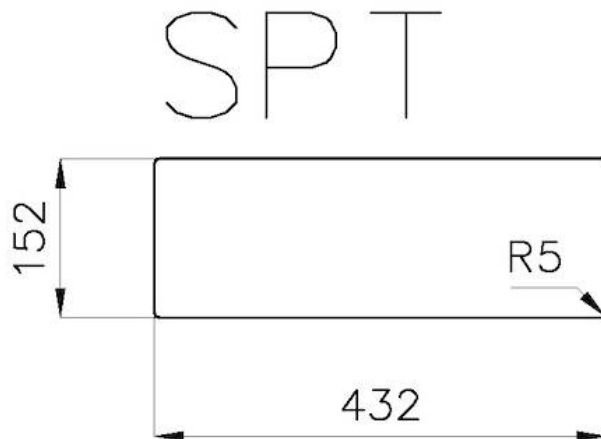
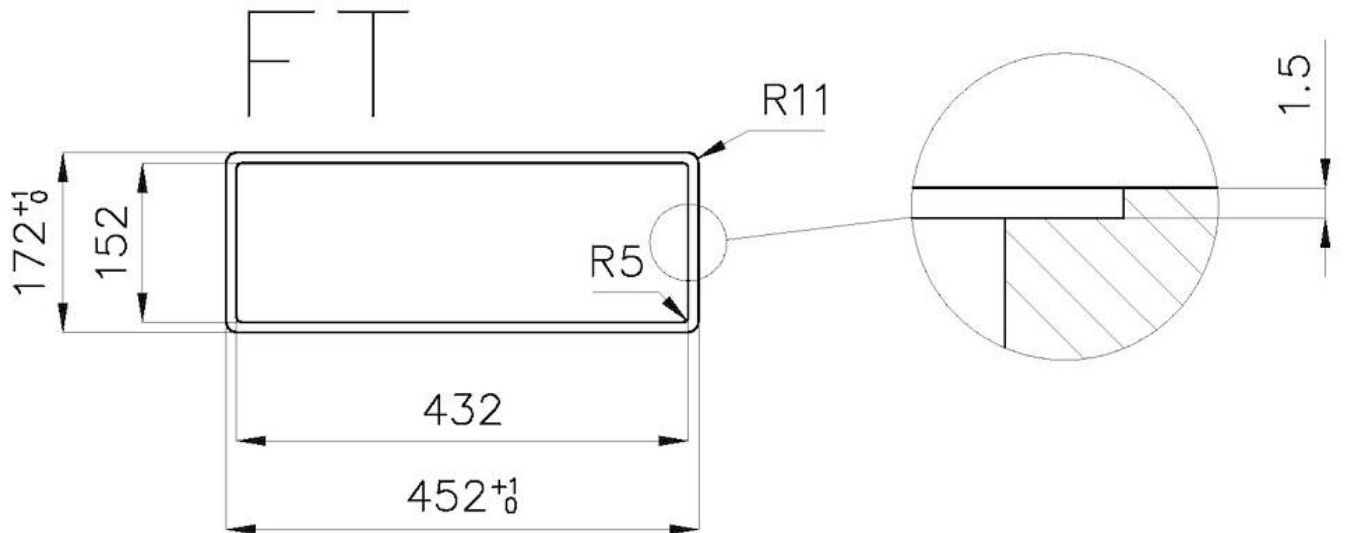

GALLERY

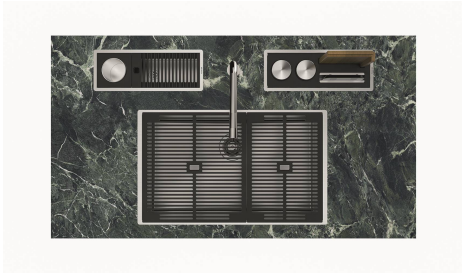

OPTIONAL ACCESSORIES



Black drainer
8100 058



Kit "A"
8100 703



Kit "B"
8100 700



Kit "C"
8100 701



Kit "D"
8100 704



Kit "E"
8100 705



Kit "F"
8100 706



Kit "G"
8100 710



Kit "H"
8100 702



Kit "N"
8100 714



Push socket-holder
8000 020



Stainless steel knife holder
8100 712



Stainless steel perforated tray
8151 003



Stainless steel plate rack
1773 100